

# Advances in Anode Monitoring

Edward J. Conroy, *Member, IEEE*, and Malcolm M. Cameron, *Senior Member, IEEE*

**Abstract**— Applications for programmable logic controllers and personal computers with the chloralkali industry continue to grow. Older multiplexed monitoring systems are being replaced with high-speed systems that can scan an entire cellroom within 2s. Average cell voltages can be decreased by 0.25 V dc or more, resulting in significant power savings or production increases. The newer systems can be installed as an upgrade to existing systems to minimize the impact on plant operations.

**Index Terms**— Anode monitoring, electrolytic, high current sensing, mercury cell.

## I. INTRODUCTION

### A. Process

THE basic mercury cell process is shown in Fig. 1. Brine is circulated through an electrolytic cell containing a titanium anode and a flowing mercury cathode. The brine decomposes into gaseous chlorine and sodium which forms an amalgam with the mercury. The amalgam flows into a decomposer, where water is added to form hydrogen and caustic soda. The reclaimed mercury is then recirculated through the cell.

The overall reaction can be characterized as

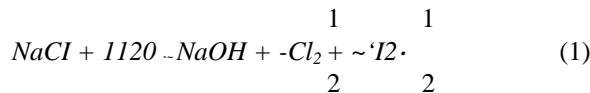

The process produces 1.1 t of caustic soda for every metric ton of chlorine. Although there are many possible configurations, we will examine a typical cellroom consisting of 52 cells connected in series by 18 parallel bus bars, as shown in Fig. 2.

The cell line load is 180 kA at 228 V dc. The cells are operated at 4.4 Vdc at a cathode current density of 11 kA/m<sup>2</sup>. The total plant load is 44 M, W and the cost of electricity averages 4.0 cents per kilowatthour.

### B. Electrical Model

The cell can be modeled as shown in Fig. 3. This simplified model consists of a series connection of conductor resistance, brine resistance, and polarization voltage. The current is,

Paper PID 97-11, presented at the 1996 IEEE Petroleum and Chemical Industry Technical Conference, Philadelphia, PA, September 23—26, and E. J. Conroy is with LEM DynAmp, Inc., Grove City, OH 43123 USA (e-mail: ejc@lem.com).

M. M. Cameron is with Universal Dynamics Ltd., Vancouver, B.C., V6J 4V3 Canada.

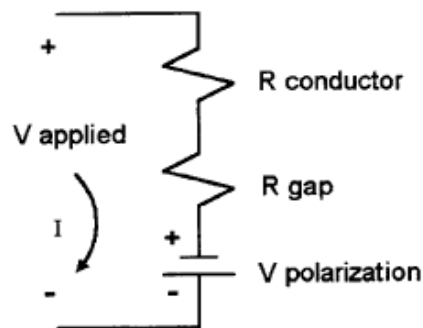
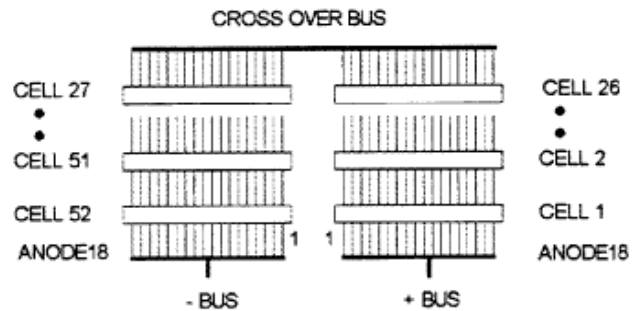
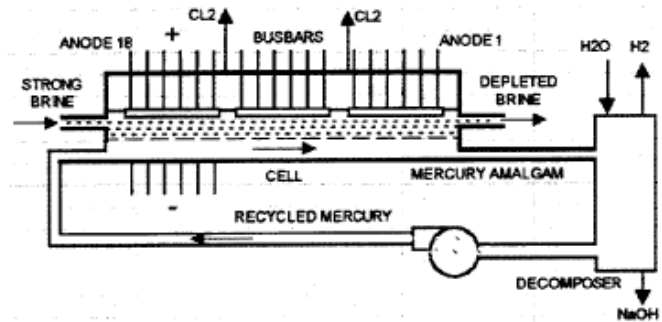

$$I = \frac{V_{\text{applied}} - V_{\text{polarization}}}{R_{\text{copper}} + R_{\text{gap}}} \quad (2)$$

The polarization voltage  $V_{\text{polarization}}$  is 3.15 Vdc. Dividing through by the anode area and rearranging, we get the corn-

monly used performance measurement:

$$k_{\text{factor}} = \frac{V_{\text{applied}} - 3.15}{I_{\text{density}}} \quad (3)$$

where  $k_{\text{factor}}$  is a function of copper resistance, anode area, brine resistivity, and gap distance, and  $I_{\text{density}}$  is the current density in units of  $\text{kA}/\text{m}^2$ . A lower  $k_{\text{factor}}$  indicates attainment of a smaller gap for a given current density, hence, less energy is lost in heating of the brine.  $k_{\text{factors}}$  range from 0.070 to 0.110.

### C. Cellhouse Configurations

Cell configurations vary greatly from plant to plant. Some of the configurations currently in use are as follows:

- 32 cells, 18 anode buses, 180 kA;
- 52 cells, 18 anode buses, 180 kA;
- 70 cells, 24 anode buses, 240 kA;
- 112 cells, 12 anode buses, 200 kA.

## II. CONTROL OBJECTIVES

The primary objectives of cell control are to:

- reduce energy consumption by reducing the gap between anode and cathode;
- achieve an even current distribution over all anodes;
- increase production by increasing current and reducing voltage (electrical energy consumption remains constant);
- reduce instances of cell shorting and associated production loss;
- reduce maintenance costs through reduced cycling of cell operation.

## III. EXISTING SYSTEMS

### A. General Configuration

In a cellhouse consisting of 52 cells, 18 anode buses, and six voltage taps per cell, there are a total of 1248 points to be monitored. As analog-to-digital converters were relatively expensive, a multiplexing system was used to connect the monitored points with a computer usually located within the control room. The major components included are as follows:

current sensors using millivolt voltage taps connected directly to the anode buses or Hall Effect transducers installed near the anode buses;

voltage sensors connected across the cell;

local control units to provide address decoding and multiplexing or current signals;

interconnect cabling consisting of:

- a multiconductor address cable;
- a multiconductor current signal cable;
- a multiconductor voltage signal cable;
- a hardwired two-wire alarm output for each cell;
- a two-wire alarm reference cable that is daisy chained to each cell;

scanner panel to provide address encoding and buffer signals received from the local control unit;

annunciator(s) to display hardwired alarm output from each cell;

central computer to provide graphical display, logging and trending, and operator input.

Operation of the system is, generally, as follows.

- The central computer sends out a binary-coded address using six wires plus common on the address cable.
- The addressed cell confirms the address using a similar scheme.
- The addressed cell connects its current and voltage signals to the signal cables.
- The scanner panel provides additional buffering and filtering, then forwards the analog signals to the central computer.
- Once the analog signals are multiplexed in, the central computer proceeds to the next cell.
- The isolation panel continuously monitors the alarm cables and controls the two annunciator panels.

The central computer is usually of an older minicomputer design and programmed in Assembler. The central computer controls the cell scanning and provides the operator with a visual display of cell currents and voltages. There may also be one or more printers.

### B. Closed-Loop Control

Some cellrooms are equipped with motorized operation of the anode frames. In most cases, however, closed-loop control is allowed only in the "raise" direction, and operator intervention is required for operation in the "lower" direction.

## IV. PROBLEMS WITH EXISTING SYSTEMS

### A. Obsolescence

Existing systems are highly customized and sometimes unique. Special consideration must be paid to:

- temperature compensation;
- voltage isolation;
  - accuracy;
- signal conditioning, attenuation, and noise;
- interfacing between various assemblies and components;
- initialization;
- computer hardware and software.

The resulting complexity makes it expensive and difficult to support these systems in the following areas:

- spare parts;
- internal training and support;
- supplier support;
- maintenance cost;
- calibration;
- modification of both hardware and software.

These problems can be addressed with currently available technology.

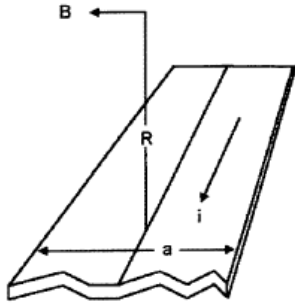

Fig. 4. Magnetic field.

## V. A NEW APPROACH

### A. System Requirements

The following requirements were identified in the selection of a new cell monitoring system.

- The system should utilize generic hardware and software, preferably programmable logic controllers (PLC's), and PC's and Windows-based programming.
- The component count and the interfacing requirements between components should be minimized.
- Communications should be digital, in order to reduce wiring requirements and signal degradation.
- The system should be capable of scanning an entire cellroom within 2 s. The requirement for a separate hardwired alarm system should be eliminated.
- Intelligence should be located close to each cell, so that reliable closed loop control can be provided.
- The system should be upgradeable, so that new technologies can be utilized as they become available.
- There should be a migration path between the existing and new system.
- The new system should be capable of higher level connectivity, so that information from the monitoring system can be utilized directly by management and operations.
- Installation should be simple and economical.

### B. Special Considerations

1) *Magnetic Field Strength:* The magnetic field strength for a strip conductor, as shown in Fig. 4, can be found as

The calculated field strength 3/8 in from a 10-in-wide busbar carrying 10 kA is 236 G. Measured values are slightly

$$B = \frac{\mu_0 i}{\pi a} \tan^{-1} \frac{a}{2R}$$

where

- $\mu_0$  permeability of free air;
- $i$  total current in strip;
- $R$  distance from strip;
- $a$  width of strip.

lower at around 200 G.

2) *Effect of Magnetic Field on Electronics:* The level of magnetic field found in cellrooms can affect solid-state

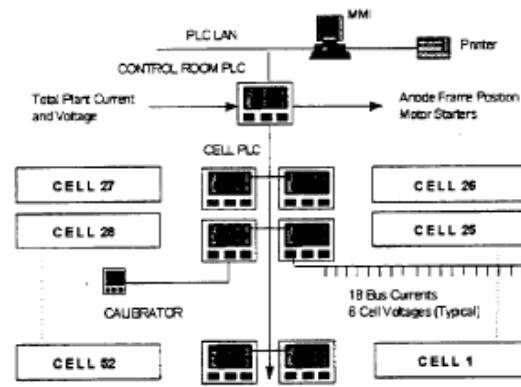

Fig. 5. New system block diagram.

electronics. Particularly susceptible are devices that contain discrete ferrite-type inductors, for example, older radio systems. Fortunately, newer PLC's do not appear to be susceptible. Site testing is recommended, as PLC's are not factory tested in this type of environment. Inquiries to PLC manufacturers invariably draw responses that apply to high frequency, rather than dc magnetic fields.

3) *Effect of Magnetic Field on Displays:* The level of magnetic field found in control rooms is usually less than 50 G. This field is strong enough to affect cathode ray tubes (CRT's) through the Hall effect. Small variations in the field can cause a "rainbow effect" with color tubes, which usually prohibits their use within control rooms. The distortion on single-color displays is tolerable with suitable shielding. The most common approach is to direct the lines of flux around the CRT by surrounding it with highly permeable steel. Solid-state displays, particularly liquid crystal displays (LCD's) are not affected by the magnetic field. They are now available in resolutions of 256 colors, 1024 x 768 pixels, and screen sizes of 14 in and higher. Although expensive, prices continue to drop as availability increases.

4) *Voltage Isolation:* Chloralkali cellrooms operate at voltages of 130–400 V dc, depending on the number of cells. Although most cellrooms are floating, single grounds can occur anywhere along the cell line. Common-mode voltage isolation on the monitoring system is, therefore, critical. Hall-effect transducers offer several kilovolts of isolation by virtue of the physical separation from the bus. On the other hand, direct connections, including millivolt bus taps and cell voltages, require separate isolation, usually optical.

## VI. NEW SYSTEM

The new approach uses a minimum number of generic components. The system is comprised primarily of current and voltage sensors, PLC's and man—machine interfaces (MMI's). Refer to the block diagram in Fig. 5.

### A. Current Sensors

New Hall-effect-type current sensors were developed. They are powered by a 12-V dc supply and provide a voltage

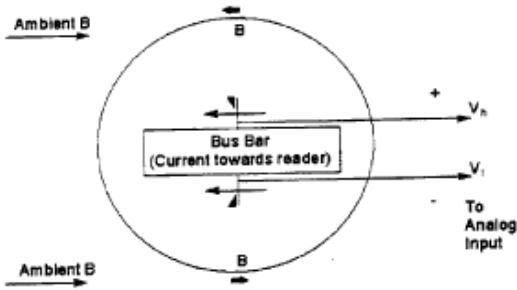

Fig. 6. Current sensor differential connection.

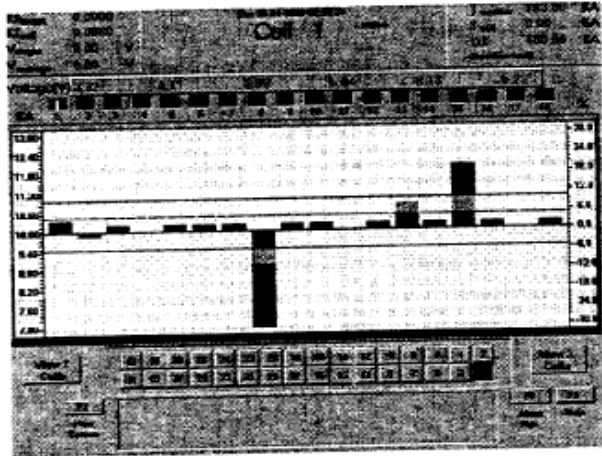

Fig. 7. MMI screen showing cell current distribution.

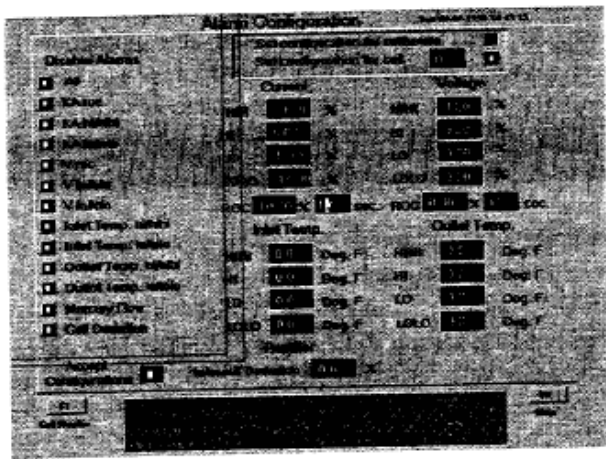

Fig. 8. MMI screen for input of alarm limits.

output signal that is suitable for direct connection to a PLC analog input. Temperature compensation is built in, and all components are contained on an integrated chip that is approximately 1/2-in square. The sensors are hermetically sealed to protect them against the cellroom environment. They can be connected in a single or dual configuration. The latter is a differential connection that cancels ambient flux and provides a signal proportional only to the signal in the measured busbar. Referring to Fig. 6, the top sensor is mounted so that its signal increases as  $B$  increases. The bottom sensor is mounted so that its signal decreases as  $B$  increases. The differential signal is derived between the two output leads. The effect of the

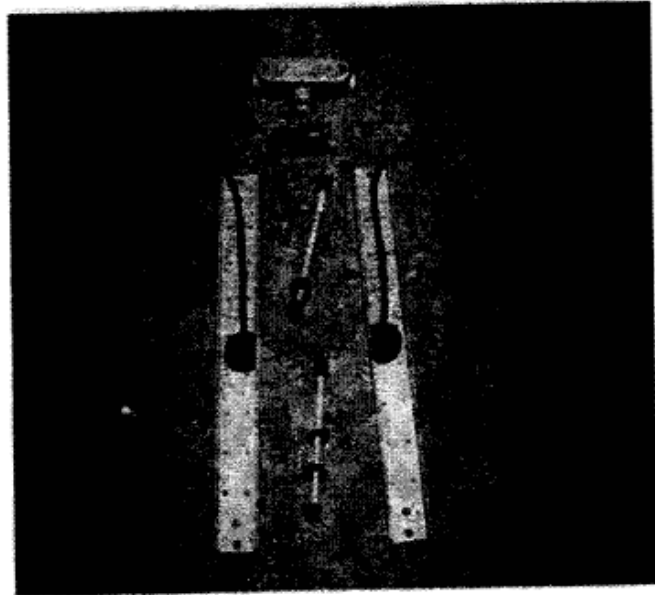

Fig. 9. Current sensors with mounting brackets.

ambient field is canceled because the output of both sensors moves in the same direction and is, therefore, canceled in the differential signal. The sensors are accurate to within 5% over a temperature range of from  $-20^{\circ}\text{C}$  to  $80^{\circ}\text{C}$ . They are capable of measuring fields from  $-600$  to  $600$  G, and they cannot be overstressed by fields stronger than their rating. The differential signal is very linear, except for small deviations near the extremes. It may be possible to improve the accuracy through software compensation in the PLC. Fig. 9 shows a picture of two current sensors and mounting hardware. The sensors are premounted on fiberglass channels that are clipped to the existing bus using threaded fiberglass rods.

### B. Voltage Sensors

The voltage across each cell is measured at six points, lengthwise along the cell. Current-limiting resistors are used at the connection points to limit the fault current in case the voltage leads become shorted. Common-mode isolation is provided by the PLC analog input cards.

### C. PLC's

The PLC's were chosen from a mainstream manufacturer. The main selection criteria included the following:

- industry acceptance, support, robustness, and familiarity to plant personnel;
- ability to network controllers in a peer-to-peer fashion;
- range of PLC sizes to handle from one to four cells each;
- scan time and PLC network token rotation time;
- ability to survive in cellroom environment;
- small physical size and ease of 110 connections;
- relatively low cost in comparison with custom-designed equipment.

The PLC's were programmed in standard ladder logic. Only four types of cards were used, in order to minimize stocking of spares. Fig. 10 shows a panel for a cell PLC. In addition

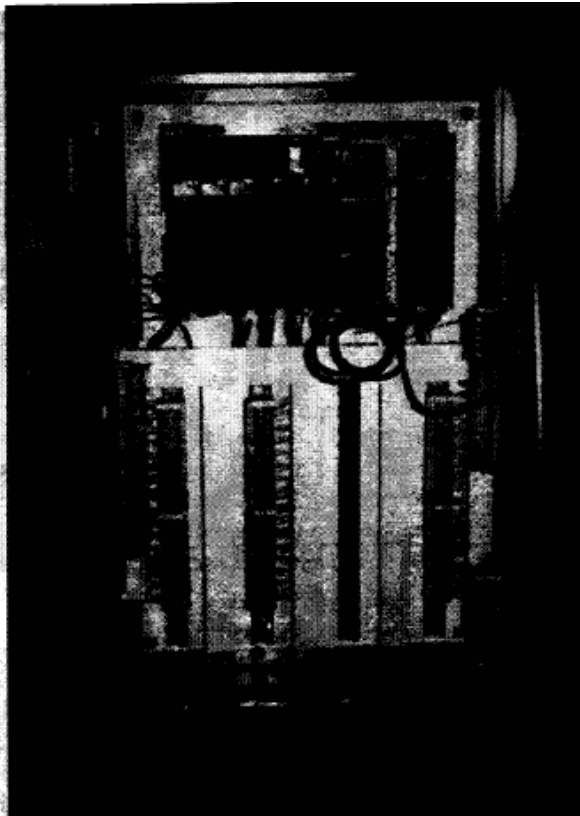

Fig. 10. PLC panel for mounting adjacent to cell.

to the PLC, the panel contains quick-connect terminators and a power supply for the current sensors.

#### D. PLC Network

The ability to communicate quickly and reliably between PLC's and MMI's is critical to the system design. It allows the communication network to be reduced from numerous multiconductor cables to a single pair. It also allows the failure-prone hardwired multiplexers to be deleted entirely.

The PLC's can be connected to service between one and four cells each. Allowing for overhead, the PLC network is capable of transferring around 10 000 registers/s. Each PLC can transfer up 100 registers each time it possesses the token, and the token is rotated at the rate of approximately one PLC per 50 ins. As a result, data from the entire cellroom can be transferred to the MMI within 2 s.

#### E. MMI

The MMI consists of an industrial laptop with an LCD screen running a generic MMI software package. The MMI software is multiplatform, meaning that it can be run on most popular operating systems, including Windows 95 and NT, OS/2, 1-IP-UX, VMS, AIX, and others. As a result, there is no need to "lock in" to a single computer manufacturer. Furthermore, the package can be migrated to take advantage of new computer technology as it becomes available. MMI display features include the following:

- full graphical interface;
- ability to enter alarm levels for each cell;

- cycling bar charts with ability to display one, two, or three cells at a time;
- fixed detail bar chart;
- alarm level and target "k" factor entry (target cell voltage will be calculated from target cell "k" factor);
- summary of "cells in alarm";
- communication system status;
- parameter trends.

Figs. 7 and 8 show sample bar chart and alarm input screens. Note the window near the bottom that shows the last three alarms.

Full alarming and logging capability is provided. Printed output consists of the following:

- alarms showing cell number, type of alarm, alarm value, time, and date;
- screen dumps of graphical displays and system summary reports;
- daily shift report of:
  - cell alarm statistics;
  - ranking of the ten worst cells;
  - average total volts, currents, average "k" factors, production, and total cell down time in hours.

#### F. Calibrator

The calibrator is also a PLC-based intelligent device. In the past, the operator of the calibrator would voice his readings to a second operator, who would then set potentiometers at the local control unit to obtain the desired reading. With the new system, the operator simply plugs into the appropriate PLC, presses a button to indicate which anode bus he is measuring, then presses a calibrate button to complete the operation. The calibration is contained entirely within the software of the PLC.

#### G. Actuators

Cells that are equipped with anode actuators normally use a single drive for each anode frame. A chain or shaft mechanism is then extended around the frame and connected to mechanical actuators. On cells that are not equipped with actuators, it may be feasible to install a gear motor at each corner of the frame, directly on the jacking bolt.

#### H. Control Routines

Anode movements are closely monitored and controlled by the PLC. The control algorithms utilize both magnitude and rate of change calculations. Note in (2) that the cell current is inversely proportional to the gap distance. The rate of change is, therefore, proportional to the square of the gap distance. The real-time behavior of adjacent cells is also monitored and is critical in the prevention of "traveling shorts."

## VII. APPLICATIONS

A demonstration system was installed at three North American chloralkali plants. The following objectives were proven:

- reliable operation of the PLC's in a cellroom environment;
- accuracy and repeatability of the new current sensors;
- operation of large LCD screens within the control room;
- reduction of cell voltage by at least 0.25 V dc;
- automatic raising and lowering of the anode frames using gear motors mounted on the frame jacking bolts.

The achievement of automatic control was particularly significant because it showed that a very accurate level of control is provided by the PLC located next to the cell. This is the benefit of the basic architecture, whereby a small PLC is used to control from two to four cells.

A partial system has also been installed into a Southeastern chloralkali plant. It involves replacement of the scanner panel, annunciators, and central computer with a PLC/MMI combination. The PLC fully emulates the scanner and reads the analog values from each cell using the existing interconnect cable system. The MMI screens and software are similar to those used on a complete new system. In fact, the plan is to provide a migration path to a new system within the next two years. The PLC/MMI combination will be reused if it is decided to install new current sensors and PLC-based monitoring. The only difference that the operator will notice is that the cellroom would then be scanned in seconds instead of minutes.

## VIII. RESULTS

Preliminary results indicate that the new system enables safe cell operation with balanced intercell currents and lower cell voltages. Additional experience with the applications described above are expected to confirm the following:

- reduced energy consumption per metric ton of product;
- reduced anode—cathode shorting;
- reduced anode damage and maintenance costs;
- reduced manpower requirements;
- reduced hydrogen generation;
- improved safety;
- improved reporting of cellroom operations;
- improved cell problem analysis;
- easier production rate change to take advantage of off-peak power rates;
- increased production rates;
- increased total production.

## IX. FUTURE ENHANCEMENTS

The architecture of the new system is open, and many enhancements are possible. These include the following.

### A. Expansion

The PLC LAN can be expanded to include up to 63 PLC's on a single network, and more, if bridges are used. The I/O can be expanded to include temperatures, pressures, and concentration. It would then be possible to model the process and simulate the effect of process changes before they are implemented.

### B. High-Level Connectivity

The MMI's can be connected to a plant-wide computer LAN, and the data available from the anode monitoring and control system could be shared by a variety of users. Users could include engineering, accounting, maintenance, and management. The interface could be implemented using a variety of currently available client/server relational database servers. The MMI software "populates" the database, and users query the database. The database provides a barrier between the anode monitoring and control system and untrained users on the computer network.

### C. Demand Control

A demand control system could be implemented by connecting metering pulses into the PLC system and providing outputs to the rectifier controls. The same MMI could serve the dual function of anode monitoring and demand control.

### D. Rectifier Monitoring and Control

The system could be expanded to include rectifier monitoring and control. Targets would include the following:

- tapehanger control;
- saturable core reactor control;
- alarm monitoring;
- diode current balance and blown fuse monitoring.

## X. CONCLUSIONS

The requirement for customized hardware and software continues to shrink as generic PLC's and PC's become more capable and easier to use. Concerns about reliability have been addressed by more advanced design and operating experience. In most cases, the PLC/PC systems are several times more reliable than the systems they replace.

In order to reduce capital outlay and disruption to ongoing operations, existing anode monitoring systems can be upgraded in several phases.

Implementation of an anode monitoring and control system can result in energy savings, increased production, or a combination of the two. As the example in the Appendix shows, an average reduction of just 0.25 V dc per cell can result in a payback of many times the original capital cost.

## APPENDIX CAPITAL BUDGETING

Capital budgeting is the process of evaluating the economics of a proposed project. The commonly used model, assuming declining balance depreciation and no salvage value, consists of three terms:

$$NPV = -C + \sum_{t=1}^n \frac{R_t(1-T)}{(1+i)^t} + C\left(\frac{dT}{d+i}\right)$$

where

- $NPV$  net present value;
- $C$  capital cost;
- $R_t$  return to before-tax net operating revenue in year  $t$ ;

TABLE I  
INCREMENTAL CONTRIBUTIONS OF THREE STRATEGIES

Optn	Revenue	Cost	Profit	$R_{\pm}$
1	\$450.00	energy \$144.00 other \$216.00 total \$360.00	\$90.00	\$0.00
2	\$450.00	energy \$135.82 other \$216.00 total \$351.82	\$98.18	\$8.18
3	\$477.11	energy \$144.00 other \$216.00 total \$360.00	\$117.11	\$27.11

TABLE II  
CAPITAL COST OF MONITORING SYSTEMS

Plant Size tonne/day	150	300	450
Capital Cost	\$1.0 M	\$1.8 M	\$2.4 M

TABLE III  
NPV OF THREE STRATEGIES

Plant Size (tonne/day)	150	300	450
Option 1	\$0.0 M	\$0.0 M	\$0.0 M
Option 2	1.86 M	3.47 M	4.91 M
Option 3	3.77 M	7.34 M	10.71 M

$T$  corporate tax rate (assume 50%);  
 $i$  interest rate (assume 15%);  
 $d$  depreciation rate (assume 30%);  
 $n$  total life of the investment (assume six years).

The first term is the initial investment, paid with after-tax dollars at time zero. The second term is the net present value of an annual flow of after-tax revenue resulting from the investment. The third term is the after-tax savings resulting from the ability to depreciate the investment over its life.

#### A. Project Economics

The installed investment cost  $C$  for various plant sizes is estimated in Table H.

Substitution of these values into the capital budgeting model yields for the three strategies the results shown in Table III.

We will consider two strategies, energy savings and increased production. In the first case, we will assume that the new control system will enable the plant to operate with a voltage decrease of 0.25 V dc per cell (from 4.40 to 4.15). In the second case, we will assume that the energy saving resulting from the decreased voltage is consumed by increasing the cell current. Hence, the overall energy consumption is unchanged. Assume also the following.

- 1.0 t of chlorine and 1.1 t of caustic soda (defined as one electrochemical unit or ECU) sell for a total of \$450.00.
- 3600 kWh at 4.0 cents per kilowatt-hour is used to produce 1.0 t of chlorine. The variable cost of production is, therefore, \$144.00 per t of chlorine.

- Electrical energy accounts for approximately 40% of the cost of production.
- Remaining costs of production are relatively fixed at \$216.00 per t of chlorine.

The incremental contributions  $R_{\pm}$  for three strategies 1) do nothing; 2) save power; and 3) increase production are calculated in Table I on a per-metric-ton-of-chlorine basis. Note the third option can only be pursued if there is spare capacity in liquefaction and other plant auxiliaries.

The NPV of the power savings (Option 2) is attractive, however, the NPV of the production increase (Option 3) is even more attractive by a factor of almost two to one.

#### REFERENCES

- [1] S. W. Hagemoen, O. K. Hung, and M. M. Cameron, "Microcomputer applications in the electrochemical industry," presented at the IEEE Petroleum and Chemical Industry Technical Conf., Calgary, Aim., Canada, 1985
- [2] R. W. Ralston and J. Warren, "Automation of mercury cell anode adjustment," presented at the IEEE Petroleum and Chemical Industry Technical Conf., Houston, TX, 1980.
- [3] F. R. Czerniejewski, "Productivity in chlorine cell lines by computerized demand control," presented at the IEEE Petroleum and Chemical Industry Technical Conf., Houston, TX, 1980.
- [4] J. H. Hilburn, P. M. Julich, and R. L. Mitchell, "A microcomputer based supervisory system for a mercury-cell line chlorine plant," *IEEE Trans. Ind. Applicat.*, vol. IA-iS, pp. 209-213, Mar/Apr. 1979.



**Edward J. Conroy** (M'83) was born in Columbus, OH, in 1946. He received the B.S.E.E. degree in 1968 from Ohio State University, Columbus.

He joined LEM DynAmp, Inc. (formerly Halmar Electronics), Grove City, OH, in 1975, as an Applications Engineer in the High Current Systems Group. He is currently the International Sales Manager for the Business Unit High Current Systems. He specializes in the application of high accuracy dc metering systems to large rectifiers and electrolysis lines. He has authored four IEEE papers.

Mr. Conroy is a Registered Professional Engineer in the State of Ohio and is active in the Electrochemical Subcommittee of the IEEE Petroleum and Chemical Industry Committee (PCIC).



**Malcolm M. Cameron** (M'81-SM'92) was born in Bralorne, Canada, in 1953. He received the B.A.Sc. (Electrical) degree in 1976 and the M.B.A. degree in 1988 from the University of British Columbia, Vancouver, Canada.

In 1980, he joined Universal Dynamics Ltd., Vancouver, B.C., Canada, where he is currently Vice President, Engineering. He has served as Project Manager on major electrical and control upgrades of chloralkali plants owned by Canadian Occidental and Georgia Pacific Corporation. He has also managed a major upgrade of a west coast grain terminal owned by Alberta Wheat Pool. Prior to joining Universal Dynamics, he worked for B.C. Hydro in production,

distribution, and substations commissioning. His interests include industrial applications of PC's, man-machine interfaces, and integration of advanced industrial control with MIS systems. He has authored seven IEEE papers.

Mr. Cameron is a member of the Canadian Mining Institute. He is a Registered Professional Engineer in the Province of British Columbia, Canada, and the State of California. He is also past Chair of the Vancouver Section of the IEEE and past Chair of the Electrochemical Subcommittee of the IEEE Petroleum and Chemical Industry Committee (PCIC).

